

ALL-NEW

soul

1.6 OR 2.0 PETROL | 6 SPEED AUTO



Overseas model shown.



The Power to Surprise

More stylish than ever

We took a groundbreaking, award-winning design and drove it into the future. The all-new Kia Soul has been invigorated and refined - inside and out - with sporty, SUV-like styling, cutting-edge technology, and upgraded performance.

soul



Built for the urban jungle

Soul is the perfect partner for navigating your way through the fun and excitement of the city. Stand out from the crowd and see for yourself why it's the truly iconic car that will turn heads.



Futuristic meets sophistication

Striking two-tone exterior colour options, distinctively designed headlamps with front LED DRLs, and rear LED combination lamps are just some of the modern design cues that come together to create a look that's distinctively Kia.



Colour on indent only



LED daytime running lights Projector headlights provide bright, crisp lighting for enhanced safety at night while LED DRLs mark your presence on the road during the day.



LED rear combination lamps Soul's signature LED rear combination lamps boast outstanding visibility along with a serious dose of style.



Outside mirror electrically folding (SX only), adjustable and heated side mirrors are available in body colour or high-gloss black finishes depending on trim level.



Tailgate Soul's distinctive backpack-styled tailgate conveys an innovative and wide rear image for a truly unique on-road presence.

More than meets the eye

Soul's distinctive styling doesn't run just skin deep. On the inside, Kia designers have achieved function that will impress even the most discerning drivers.



It's all in the details

Front and centre is the high-tech instrument cluster with deeply recessed gauges that provides a vast array of logically displayed vehicle information.

SX only

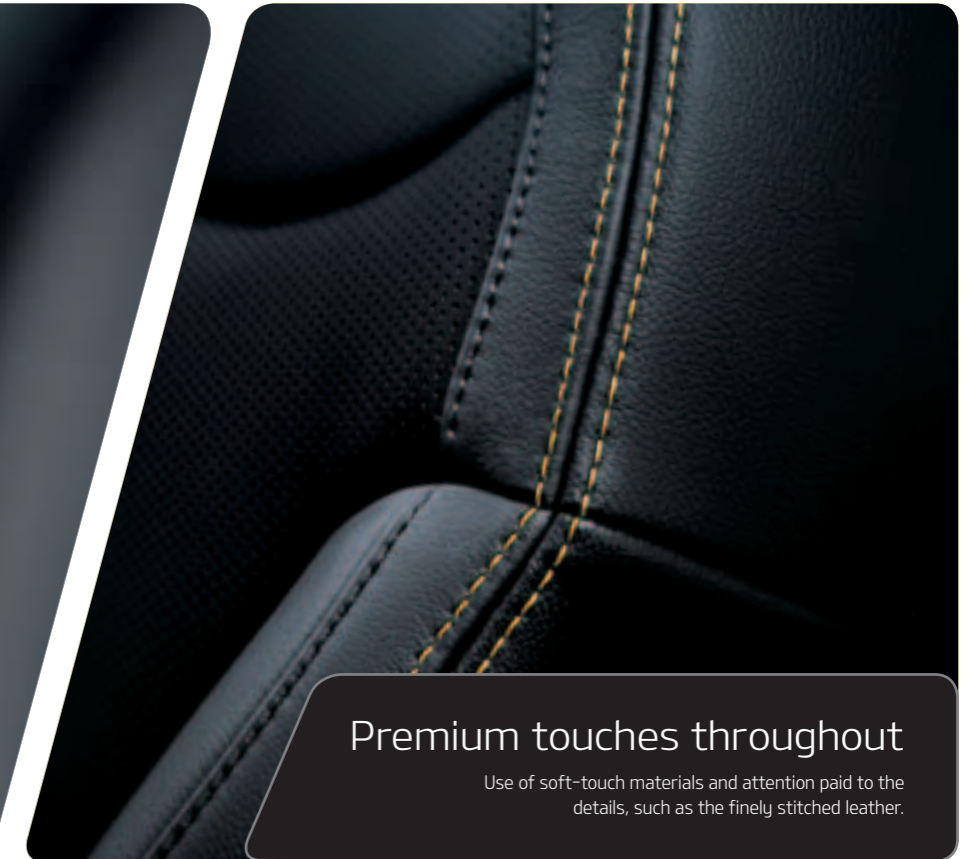

Premium touches throughout

Use of soft-touch materials and attention paid to the details, such as the finely stitched leather.

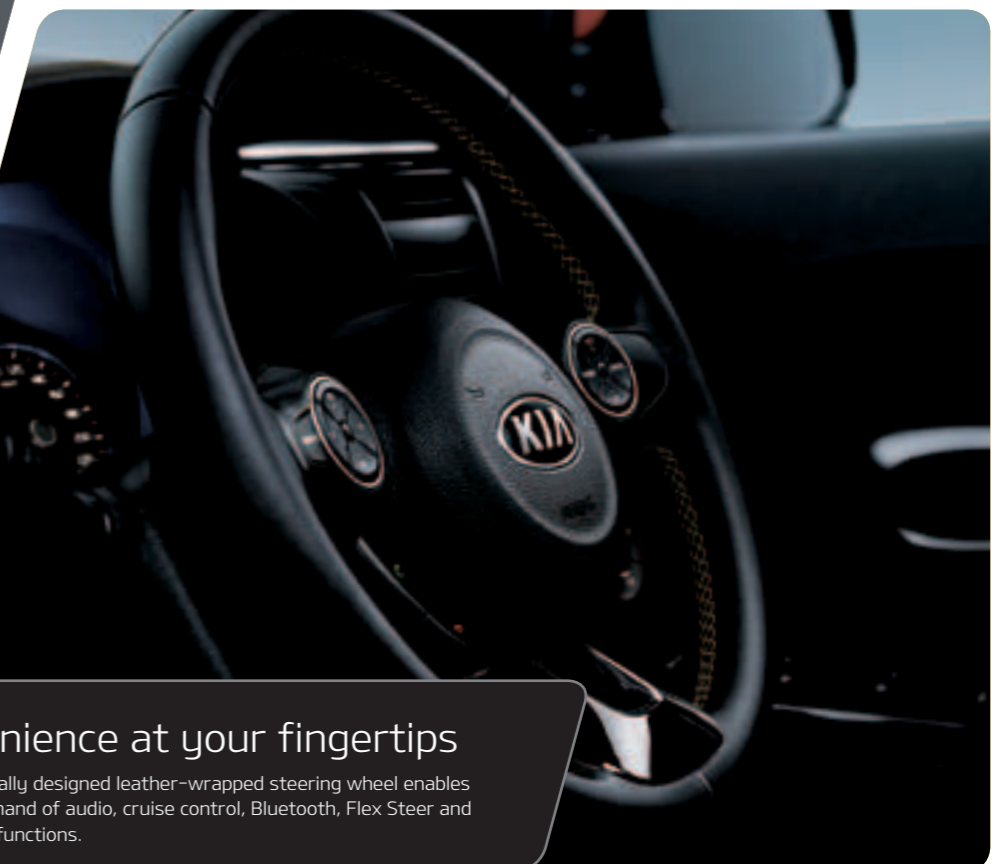

Convenience at your fingertips

An ergonomically designed leather-wrapped steering wheel enables intuitive command of audio, cruise control, Bluetooth, Flex Steer and trip computer functions.

A stunning interior to match

Soul's round gear shift knob, circular groupings of steering-wheel mounted controls, and spherical, high-mounted 'floating' tweeters create an organic, circular-themed cabin that will appeal to drivers and passengers alike.



Push button start

The unique position of the engine start/stop button at the front of the floor console next to the great shift lever offers both convenience and a sporty touch.



SX only



Integrated air vents and tweeters
The front side air vents are seamlessly integrated with the spherical, high-mounted 'floating' tweeter speakers as a stylish extension of the circular theme found throughout the interior.



Aux, iPod®, USB connectivity
Plug in and play your favourite music from a variety of mobile storage devices such as iPod®, iPhone® or iPad®.



SX only

4.3" TFT- LCD

Taking centre-stage is a high-tech supervision cluster with 4.3" TFT-LCD that displays a comprehensive range of vehicle information.



High-tech audio system

A 4.3-inch colour touchscreen provides excellent visibility and operability while also including a rearview camera display and high-end radio and MP3 controls for enhanced convenience.

Immerse yourself in a world of comfort

We know that you'll want to spend as much time as possible in your new Soul. That's precisely why we've gone the extra mile to ensure you and your passengers can relax and enjoy the ride.



Improved ingress and egress

The seat cushion height and distance between the cushion and roof line have been optimised to make getting in and out of the Soul easy for people of all heights.



SX only

8-way power driver's seat / lumbar support

Conveniently located controls allow you to electronically dial in your ideal seating position while 2-way adjustable lumbar support lessens fatigue during long drives or when you are stuck in traffic.

3-way ventilated and heated front leather seats

Both the driver and front passenger leather seats are ventilated and heated for enhanced comfort. Warm or cool air is blown through the seat and backrest cushions, preventing perspiration build up on hot days and keeping you cosy in the winter.

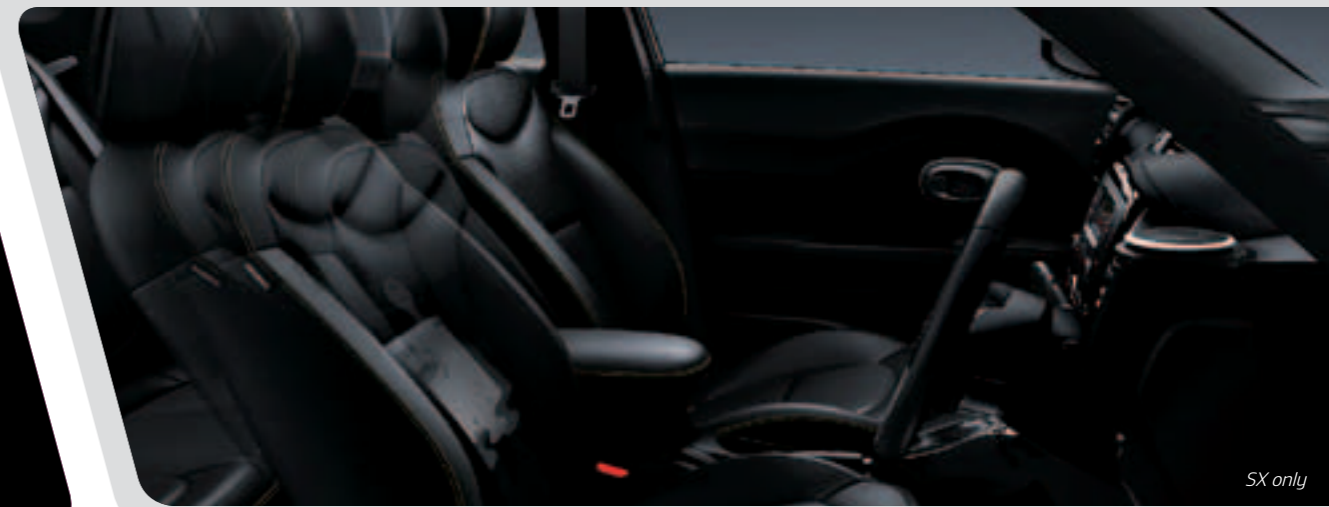

SX only

Engineered for you

Whether hard at work or hard at play, you'll take notice of Soul's impressive blend of safety and vehicle dynamics that puts the fun back into driving.



Flex Steer

Choose from three driving modes - Normal, Comfort and Sport - to fine tune the steering feel depending on conditions and preference.

Steering Mode

SPORT



Steering Mode

COMFORT



Steering Mode

NORMAL



Show off your individual style

Get ready to explore the exciting opportunities that the city has to offer while leaving your own personal imprint on the urban landscape.



Auto cruise control

Conveniently adjust cruise control settings without removing your hands from the wheel with ergonomically designed buttons on the steering wheel.

Safe in any situation

Like all of Kia's new generation passenger vehicles, Soul is available with a host of advanced active and passive safety technologies that give you peace of mind under New Zealand driving conditions.



Front and rear parking sensors

Obstacles at the front and rear of the vehicle are automatically detected and an audible alert sounds with increasing intensity as the car approaches an impediment.



EX: Rear only
SX: Front and Rear



Driver, passenger, side and curtain airbags

A 6-airbag system offers protection for all occupants and can be effective at reducing injuries from certain collisions.



406.4mm disc brakes

Robust disc brakes provide powerful braking performance as well as a sporty touch.

16 inch SX model only



BAS (Brake Assist System)

BAS greatly reduces the stopping distance during sudden braking situations by applying maximum brake force when needed.



VSM (Vehicle Stability Management)

VSM helps ensure the car stays stable when accelerating or braking suddenly - especially on wet, slippery and rough roads.



HAC (Hill-start Assist Control)

HAC prevents the vehicle from rolling backward when at a standstill on an upward incline by gently applying the brakes for up to two seconds while moving your foot from the brake pedal to the accelerator.

Excitement and efficiency on the go

All-new Soul is available with a range of responsive yet efficient engines coupled with an advanced 6-speed automatic transmission. Whichever combination you choose, you'll add spice to your commute while spending less time at the gas pump.



6-speed automatic transmission
This compact, lightweight unit offers durability and smooth shifting while manual mode is positioned next to the driver for ease of operation.

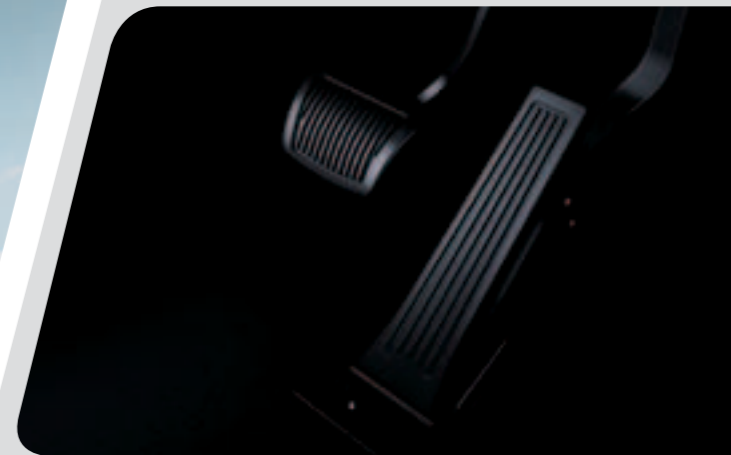

Organ-type accelerator pedal
This accelerator pedal moves along the same natural plane as your foot for more comfortable operation, especially on extended journeys.



Gamma 1.6 MPI Engine
Displacement 1,591 cc
Maximum Power 91kW @ 6,300 rpm
Maximum Torque 152Nm @ 4850 rpm

Nu 2.0 MPI Engine
Displacement 1,999 cc
Maximum Power 113kW @ 6,200 rpm
Maximum Torque 191Nm @ 4700 rpm

Use your imagination

Express your individuality every day. A choice of sporty and distinctive two-tone exterior options and a wide range of wheel styles allow you to create the ideal soul mate that will help you stand out from the crowd.



Premium quality upholstery
Careful attention was paid to the selection of top-quality seat materials that provide a level of chic sophistication rarely seen in same-segment cars.

215/55R 17" Alloy Wheel EX
(Metallic alloy)



235/45R 18" Alloy Wheel (SX)
(Machine finished)



As eco-conscious as you are

So you value sustainable living? We do too. That's why we take pride in rising to meet the expectations and challenges of the 21st century while making tangible contributions to the preservation of the environment and sustainable development of society as a whole.

Kia Motors designated environmental management as one of the core objectives of our socially responsible management initiative launched in 2008 and has put the environment at the forefront of all our business activities. We aim to spearhead efforts to combat the global challenges of natural resource depletion and climate change.

We are applying innovative automotive technologies to dramatically improve energy efficiency and are making consistent investments in technology innovation to commercialise hybrid, electric and fuel cell vehicles. We are also building a clean production system, raising the

resource recovery rate, designing vehicles with the disposal phase in mind, increasing energy efficiency, and adopting low-carbon fuels.

Wherever possible, recycled and recyclable materials are being used in the production of every Kia. Even at the end of your car's life, one of our environmental targets is the eco-friendly return and treatment of end-of-life vehicles. Operating a rigid process, we guarantee environmental protection in the treatment of harmful waste substances. These are then recycled or recovered, ensuring the highest level of environmental protection.

In short, we are committed to finding fundamental solutions to cut energy consumption and combat climate change. As you see, what you do on a small scale with your household refuse, we at Kia Motors do on a large scale around the world.



Setting a new standard of convenience

All-new Soul is equipped with a host of standard and optional amenities that provide an unsurpassed level of flexible storage, cosy comfort and peace-of-mind convenience. We've thought out every last detail so that you can sit back and enjoy the drive.



Spacious cargo room

All-new Soul offers class-leading luggage capacity of 354(VDA), enlarged rear hatch opening width and height, and rear seat full-folding and 60:40 folding for ultimate convenience when transporting items of almost any shape or size.



Covering shelf trim

A separate, partitioned-off space can be created to store away valuable items out of sight from prying eyes.



Audio remote control

Intuitively mounted controls on the steering wheel allow you easily adjust audio volume and change stations without taking your hands from the wheel.



Seat side tray

A nifty bin located on the side of the front passenger seat provides an additional space for storing away small items.



Center console

Dual cup holders, a 4.5-litre storage bin under the armrest and a 1.1-litre front tray for small items provide added convenience.



SX only

ECM mirror

The rear view mirror automatically dims the harsh glare of reflecting lights to ensure maximum visibility and safety during nighttime driving.



SX only

Climate air conditioning

Featuring set-and-forget functionality, the system automatically turns on and off to maintain the desired temperature while the clean air system eliminates unwanted odours.



SX only

Smart key remote

Even when tucked away in a pocket or purse, you can start and stop the engine or lock and unlock doors at the push of a button.



High-mounted stop lamp

Providing trailing drivers with a clear signal of your intent to slow down, Soul's high mounted stop lamp is also available with LEDs for even more visibility and style.



Surface-mounted roof rail

The integrated roof rack is designed for maximum luggage carriage support while available accessory cross bars provide more utility.



SX only

Black high-gloss rear bumper



EX only

Body colour rear bumper



SX only

Black high-gloss front bumper



EX only

Body colour front bumper

SPECIFICATIONS

KIA SOUL	EX 1.6	SX 1.6	SX 2.0
MECHANICAL			
Engine type	1.6L DOHC CVVT petrol engine		2.0L DOHC CVVT petrol engine
Displacement (cc)	1591cc		1999cc
Compression ratio	10.5		10.3
Maximum power	91kW @ 6300rpm		113kW @ 6200rpm
Maximum torque	152Nm @ 4850rpm		191Nm @ 4700rpm
Fuel economy (combined cycle)*	8.2L / 100km		8.4L / 100km
CO ₂ emissions (g/km)	192		195
TRANSMISSION			
Gearbox	6 speed automatic with sequential sportshift		
Hill start assist control	•	•	•
SUSPENSION			
Front suspension	Macpherson struts with coil springs and gas shock absorbers		
Rear suspension	Coupled torsion beam axle with coil springs and gas shock absorbers		
WHEELS			
Braking system	Ventilated front discs, solid rear discs with ABS, BAS, EBD and ESP		
Brake disc size (front/rear)	15"/14"	16"/14"	
Tyres	215/55 R17	235/45 R18	
Alloy wheels	17"	18"	18"
Tyre pressure monitoring system	•	•	•
STEERING			
Steering system	MDPS power assisted rack and pinion		
Minimum turning radius kerb to kerb (m)	5.3		
Flex steering (Normal/Comfort/Sport modes)	•	•	•
Steering wheel adjustment	Tilt and Telescopic		
SAFETY FEATURES			
ABS brakes with EBD and BAS	•	•	•
Electronic stability programme (ESP)	•	•	•
Dual front airbags	•	•	•
ISO fix childseat anchors	•	•	•
Dual side airbags	•	•	•
Dual (front to rear) curtain airbags	•	•	•
Child safety rear door locks with key activation	•	•	•
Remote keyless entry with alarm	•	•	•
Engine immobiliser	•	•	•
Front seatbelt pre-tensioners/load limiters	•	•	•
3 x rear ELR diagonal belts	•	•	•
Active front headrests	•	•	•
Parking sensors	Rear	Front and Rear	Front and Rear
Reversing camera	•	•	•
EXTERIOR FEATURES			
Headlights	Projector Type		
LED daytime running lights (DRLs)	•	•	•
LED rear tail lights	•	•	•
Electrically adjustable heated mirrors	•	•	•
Electric folding mirrors	•	•	•
LED indicators mounted in side mirrors	•	•	•
Front and rear bumper garnish	Body Colour	Black High Gloss	Black High Gloss
Front fog lights	•	•	•

KIA SOUL	EX 1.6	SX 1.6	SX 2.0
EXTERIOR FEATURES CONTINUE			
Roof rails	•	•	•
Front and rear mudguards	•	•	•
Rear privacy glass	•	•	•
INTERIOR FEATURES			
Interior trim	Woven Cloth	Composite Leather	Composite Leather
Leather steering wheel and gearshift	•	•	•
Electric driver's seat with 8 way adjustment	•	•	•
Electric driver's seat lumbar adjustment	•	•	•
3 stage heated and ventilated front seats	•	•	•
60:40 split folding rear seats	•	•	•
COMFORT AND CONVENIENCE			
Stereo system	4.3" touchscreen radio/MP3 with 6 speakers		
Aux input with USB capability	•	•	•
Bluetooth hands-free**	•	•	•
Air conditioning	Manual	Climate	Climate
Auto windscreen defog system	•	•	•
Smart proximity key with engine start/stop button	•	•	•
Steering wheel mounted cruise and audio controls	•	•	•
Power windows with driver/passenger auto operation	•	•	•
Remote central locking	•	•	•
Instrument cluster display	LCD	4.3" TFT supervision display	4.3" TFT supervision display
Auto light control with welcome/escort function	•	•	•
Active eco function	•	•	•
Electrochromic rear view mirror	•	•	•
Dual map lamps with sunglasses case	•	•	•
Front cup holders	•	•	•
DIMENSIONS			
Overall length	4140 mm		
Overall width	1800 mm		
Overall height	1612 mm	1618 mm	
Wheelbase	2570 mm		
Minimum ground clearance	143 mm		
WEIGHT AND CAPACITIES			
Kerb weight minimum/maximum	1240/1392 kg		1259/1408 kg
Luggage capacity (VDA)	354 litres		
Fuel tank capacity	54 litres		
Towing capacity - unbraked (kg)	550		
Towing capacity - braked (kg)	1100		
WARRANTY AND SERVICING			
Warranty Programme	5 year/100,000 km (whichever comes first) warranty programme		
Service Programme	Inclusive 3 year/45,000 km (whichever comes first) service programme		
Roadside Assistance	5 year/unlimited km 24 hour roadside assistance		

Specifications, equipment and colours shown in this brochure are subject to change without notice or obligation.

* Fuel consumption figures shown are from standard Australia Design Rules tests and are stated for the purpose of comparison. Actual results achieved will differ according to operating conditions and driving style.

** For a full list of compatible handsets visit www.kia.com/nz

Body colours

New chic colours along with time-tested favorites mean a colour palette that will bring out the artist in you.



Clear White



Black



Inferno Red



Toffee



Newport Blue



New Vanilla Shake

Above colours are available on indent orders

Two tone colours



Clear White + Inferno Red



Newport Blue + Clear White

Two tone colours



Mustard (SX only)



Titanium Gray



New Vanilla Shake + Black



Bright Silver



Inferno Red + Black

Specifications (mm)

	(16" TyRE)
Overall length	4,140
Overall width	1,800
Overall height	1,600
Wheelbase	2,570
Wheel tread (front)	1,576
Wheel tread (rear)	1,588
Overhang (front)	840
Overhang (rear)	730
Legroom (front)	1,040
Legroom (rear)	994
Headroom (front)	1,006
Headroom (rear)	1,003
Shoulder room (front)	1,410
Shoulder room (rear)	1,390

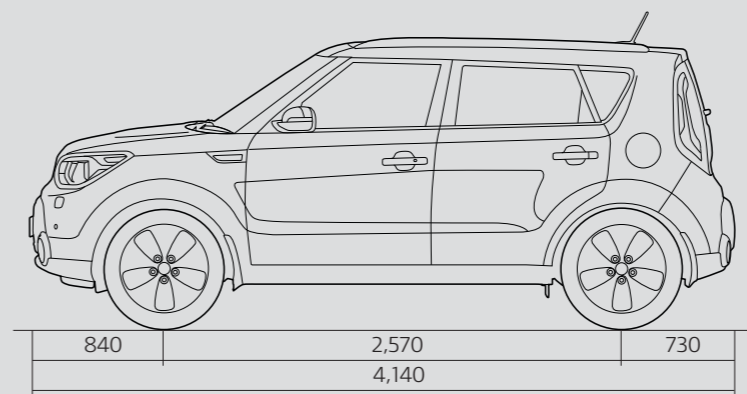
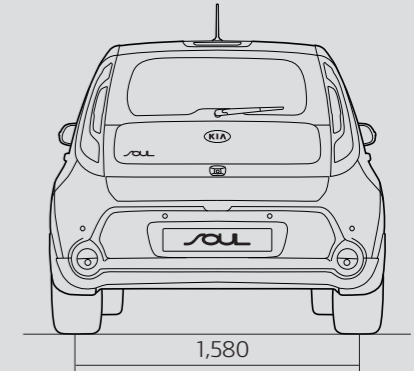
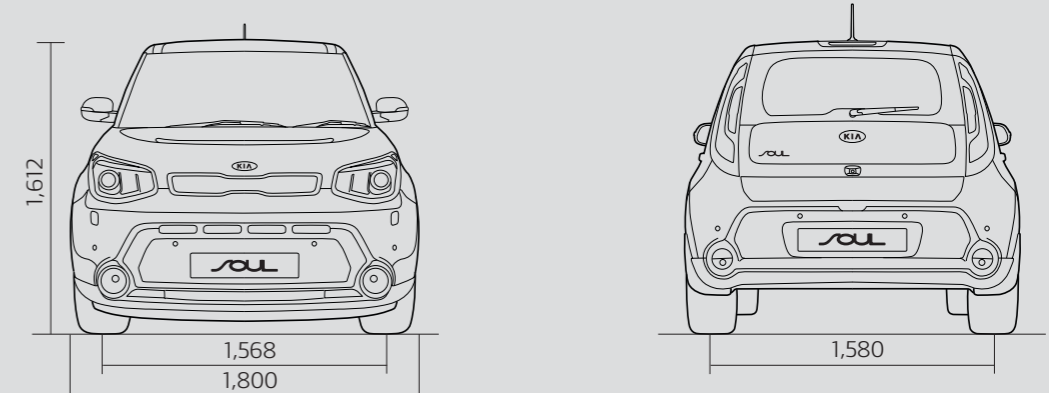

All information contained herein was based upon the latest available information at the time of printing. Descriptions are believed to be correct, and Kia Motors Corporation makes every effort to ensure accuracy, however accuracy cannot be guaranteed. From time to time, Kia Motors Corporation may need to update or make changes to the vehicle features and other vehicle information reported in this brochure. Some vehicles shown include optional equipment that may not be available in some regions. All video and camera screens shown are simulated. Kia Motors Corporation, by the publication and dissemination of this material, does not create any warranties, either express or implied, to any Kia products. Contact your local Kia dealer for the most current information.
 © 2014 Kia Motors Corporation. Reproduction of the contents of this material without the permission of Kia Motors Corporation is prohibited.

The Power to Surprise

Kia is the newest and most exciting force of change in the automotive world and we are ready to change the way you feel and think about driving. More than just a promise, we are committed to making driving a true pleasure for customers across the globe. With youthful styling and the latest in advanced technologies, Kia cars are turning heads the world over with the power to surprise. From the Picanto to the Sorento, Kia offers a full line-up of cars, SUVs and MPVs that are not only practical but downright exhilarating to drive. Keep your eyes on Kia because the best is yet to come.

About Kia Motors Corporation

Kia Motors Corporation (www.kia.com) - a maker of quality vehicles for the young-at-heart - was founded in 1944 and is Korea's oldest manufacturer of motor vehicles. Over 2.7 million Kia vehicles a year are produced in nine manufacturing and assembly operations in five countries which are then sold and serviced through a network of distributors and dealers covering around 150 countries. Kia today has over 47,000 employees worldwide and annual revenues of US\$42 billion. It is the major sponsor of the Australian Open and an official automotive partner of FIFA - the governing body of the FIFA World Cup™. Kia Motors Corporation's brand slogan - "The Power to Surprise" - represents the company's global commitment to surprise the world by providing exciting and inspiring experiences that go beyond expectations.'

Kia Motors New Zealand Ltd, 6 Highbrook Drive,
East Tamaki, Auckland 2013, PO Box 204090,
Highbrook, Auckland 2161
Telephone: +64 9 573 6070 or 0800 639 542.

